

**MANUAL FOR A CREAMING MACHINE ON A
DECRYSTALLIZER WITH AUTOMATIC CONTROLLER
C-01
POWER SUPPLY 400V
(50l-200l, 600L)**



LYSON  **SON**

Przedsiębiorstwo Pszczelarskie Łysoń

Spółka z o.o.

34-124 Klecza Górna, st.Pszczela 2, Poland

www.lyson.eu, e-mail; lyson@lyson.com.pl

Tel. +48 33/875-99-40, +48 33/870-64-02

The following manual encompasses the devices bearing the following codes:

POWER SUPPLY 400V:

W20087, W20087C, W20085, W20086, W20089,
W200890

1. General safety principles for using the creaming machine
 - 1.1. Electric safety
 - 1.2. Usage safety
2. Characteristics for a creaming machine with a heating mantle
 - 2.1 Honey creaming
 - 2.2 Diagram for the creaming machine with heating mantle
 - 2.3 Technical parameters for the creaming machines
3. C-01 controller for the creaming machine – power supply 400V
 - 3.1 Button description – controller functions
 - 3.2 Setting up the “stirring cycle”
4. Temperature regulator
 - 4.1 Setting up the controller
 - 4.2 Starting the controller’s operation
 - 4.2 Error report for the controller
5. Storing the creaming machine with a heating mantle
6. Cleaning and maintenance
7. Recycling
8. Guarantee

2. Characteristics of the creaming machine with a heating mantle



The honey creaming machine with a heating mantle is intended to cream and melt the crystallised honey. The proper design of a stirring propeller made of stainless and acid resistant steel allows to cream the honey precisely.

2.1. Honey creaming

Fresh honey remains dense and transparent. With time it is subject to natural crystallization. Proper temperature for crystallization ranges between 16-18°C. With higher temperatures, the crystallization process slows down and the crystals have bigger sizes

Heating honey until the temperature of 40°C and its maintenance by several days makes the honey switch from crystallized state (set honey) to liquid state (strained honey).

Creaming remains a quick and simple method to produce creamed honey. It consists in adding crystallized honey (set honey) to freshly centrifuged and clear liquid honey (strained honey) in order to initiate controlled, fine-grained (creamed) crystallization. The creaming process should be run in repetitive cycles:

Stirrer operation - 15 min; stirrer stoppage 1h.

The creaming machine possesses a special mechanical stirrer which allows to perform the re-crystallisation process, after which honey achieves a consistency similar to chocolate creams.

The process is based on cyclical aeration and intensive honey stirring for several days until the proper consistency has been achieved. Honey stored in constant temperature shall maintain the consistency for many months.

Mixing is to be performed several time in a day for approximately 10-15 minutes.

For example, one may start by adding crystallised honey to the liquid one.

"Creaming" is intended to formulate numerous small crystallization nucleuses and to block the expansion of the already existing honey crystals. It is referred to as "mechanical honey crystal creaming".

2.2. Diagram for a honey creaming machine with a heating mantle

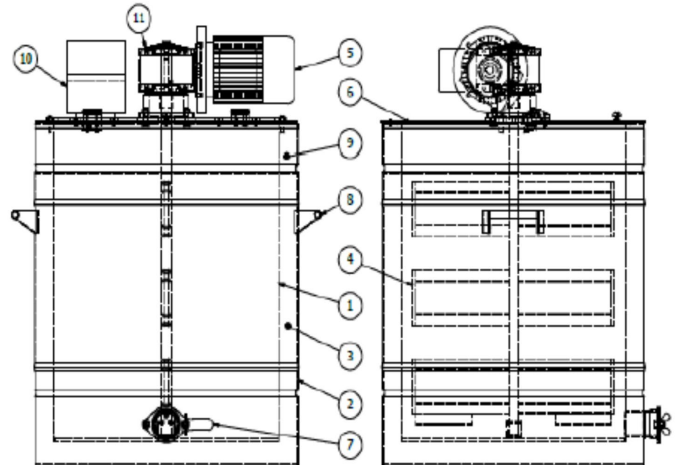

Legend:

1. Internal mantle
2. External mantle
3. Insulation
4. Stirrer
5. Engine
6. Cover
7. Stainless steel valve
8. Grips
9. Heating cable
10. Controlling
11. Transmission

2.3. Device technical parameters

- a. tank made of stainless and acid resistant steel plate
- b. transmission engine power supply 400 V
- c. digital display in the temperature regulator.
- d. rotational speed for the stirrer – 36 rpm
- e. stainless steel valve 5/4", 6/4", 2"

3. C-01 CONTROLLER FOR THE CREAMIGN MACHINE – POWER SYPLY 400V

Automatic controller controls the operation of the stirrer. Controller operation boils down to cyclical activation and deactivation of the creaming machine stirrer engine . The number of cycles for engine activation depends on the total operating time, however it is calculated in the following manner, each 15 minutes of the stirrer operation corresponds to 1 hours of stoppage (optimal parameters for the creaming process).

For example, the cycle with the total duration of 24 hours means 20 cycles of engine activation for 15 minutes each as well as 19 stoppage cycles of 1 hour each one

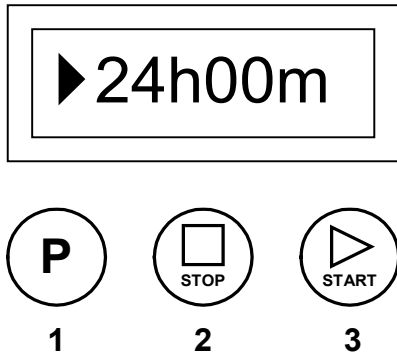

Fig 1. Creaming machine controller handling panel

3.1. Description of buttons – functions of the controller

Once power supply is connected, the controller performs self-diagnostics to acknowledge the correct device operation. Error detection is signalled by the relevant code being displayed on the LCD screen



If errors have not been detected, the screen display will look like in Fig. 2.



Fig. 2. Depending on the previous set-ups, the screen will display previously preset creaming machine operating time.

The controller possesses several programmes, which allows to select precisely the total creaming time ranging from 24 hours to 99 hours as well as 1 hour in special cycle (for the devices on a de-crystallizer).

Controller handling boils down to the selection of a programme (by pressing the “P” button and subsequent activation of selected programme cycle by pressing the **START** button.

In order to select a proper operating time for the creaming

machine, “P” button shall be pressed, as in Fig. 3 and the device operating time shall be set: (24h, 36h, 48h, 60h, 72h, 84h, 96h, 99h).

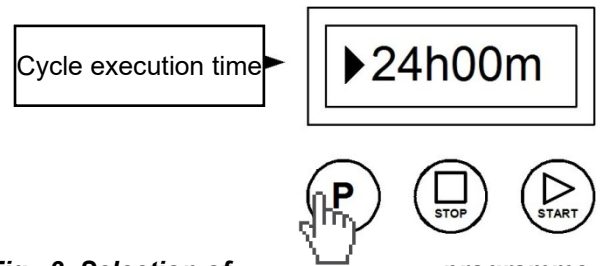
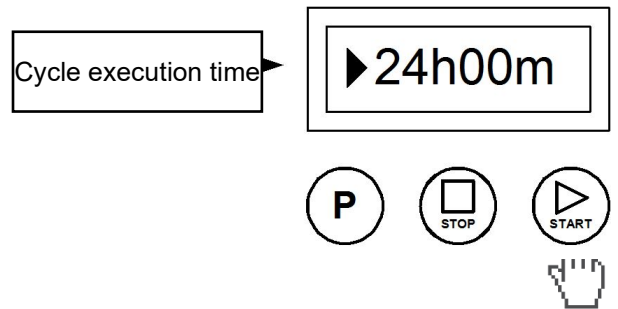

Fig. 3 Selection of programme.

In order to activate the creaming machine stirrer operation, press **START** button, as in Fig. 4



Rys. 4 Programme activation

The screen of the controller working with activated creaming cycle specifies the time that has passed since the cycle activation. (Fig. 5). Additional icon informs about the stirrer activation mode. (no icon – stirrer stoppage, visible icon – stirrer rotates)

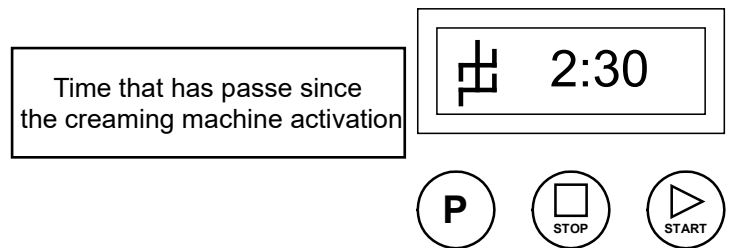

Fig 5. Activated creaming cycle

STOP button allows to deactivate the programme performed (Fig.6).

Re-activated programme will operate from the beginning, i.e. operating throughout the entire time specified.

Proper termination of the creaming cycle is signalled by an inscription OK (Fig.7) showed in the display screen

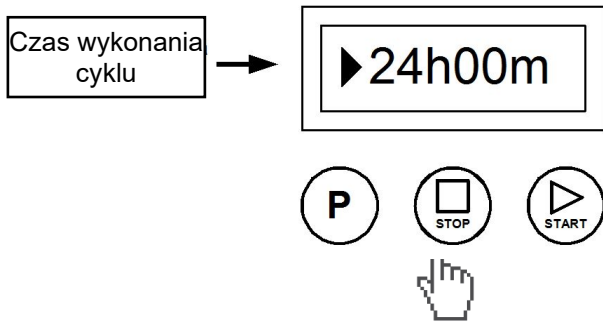

Fig. 6 Stopping the creaming process.

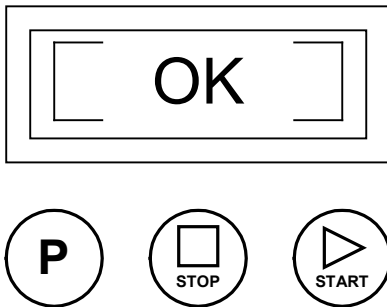

Fig. 7 Terminated creaming cycle

3. 2 SETTING UP THE “STIRRING CYCLE”

The “Stirring Cycle” allows to configure the controller from constant stirrer operation for one hour.

Activation of the cycle is possible only in the creaming machines equipped with heating system (i.e. on the de-crystallizer) !!!

In order to activate the Stirring Cycle, during the controller start-up (“**ŁYSON-C01**” note shall appear), one should press and hold **STOP** button and **P** button at the same time.

Having entered the menu on the display screen, a message informing on the active programming mode (“Prog”) is displayed and when both buttons are released the current configuration of the “Stirring Cycle” is showed

Changing the “Stirring Cycle” configuration is possible by pressing the “**P**” button.

Configuration **1h=on** (permanent stirring for 1 h) means that 1h programme will be on. Respectively, configuration **1h=off** (permanent stirring for 1 h) means 1 h function will be off.

Leaving the “Cycle programming” is possible by pressing STOP button.

P = 1h (permanent stirring cycle),

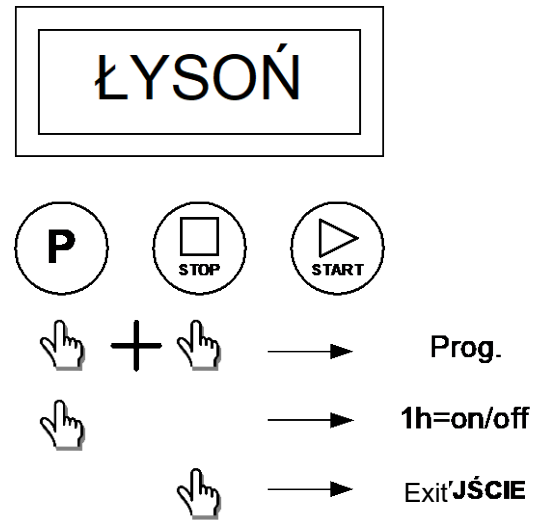

Fig. 8. „Stirring cycle” for the controller

Once the creaming machine cover has been opened, security lock mounted on the creaming device cover shall stop the creaming cycle (stoppage state, if such one was active). STOP message will appear on the display screen and time counting will stop. Cover reclosing means the return to the state in which the controller was before the safety cover had been opened, i.e. continuation of the cycle stopped.

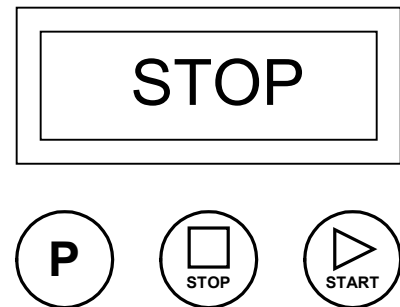

Fig. 9. Message regarding the creaming machine stopping.

Error codes

FAILURE CODE	FAILURE DESCRIPTION
E-001	INTERNAL FAULT OF THE MICROPROCESSOR CONTROLLER
E-002	PRESSED/BLOCKED “ START ” BUTTON
E-003	PRESSED/BLOCKED “ P ” BUTTON
E-004	PRESSED/BLOCKED “ STOP ” BUTTON

4. Temperature regulator MHC-01

The device has been equipped with MHC-01 temperature regulator.

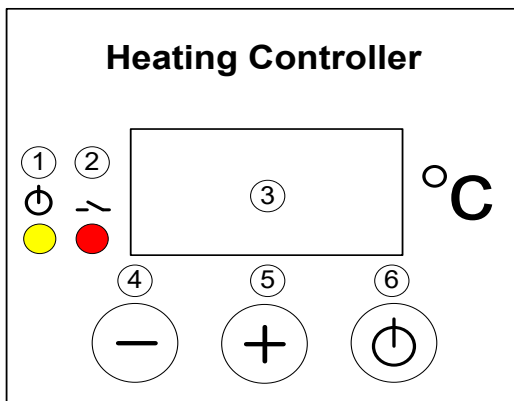

4.1. Setting up the controller

1. Prior to plugging in the device to the mains, one must make sure that the controller is switched off.
2. Switch (0/1) on the control panel shall be in "0" position
3. Once plugged in to the mains, Switch (0/1) shall be moved from "0" position to "1" position
4. Controller should be programmed in line with individual needs
5. In order to enter the programming mode (Prog), buttons "+" and "-" must be pressed at the same time during controller start-up.

4.2. Starting work with the controller

1 – signalling the work state

Indicator lights up – temperature regulator switched on,
indicator dimmed – temperature regulator switched off (controller operates as an ordinary thermometer),
indicator flashes – temperature regulator switched on and initial heating in progress

Indicator lights up – transmitter contacts closed (heating on),
indicator dimmed – contacts opened (heating off)

3 – display

Working mode – default mode, selected after controller power supply switched on. The display shows the measured temperature, readings specified in °C.

Setting mode – selected when button "+" or "-" has been pressed. The display shows the preset temperature. Readings specified in °C. Reading flashes and returns to measured temperature after a while.

Working time setting mode (Pro.) – activated when "ON/OFF" button is pressed and held. The display shows working time, counting it from activation, after which the thermostat gets switched off. Readings specified in hours.

Display brightness setting mode (d.br.) – activated when "ON/OFF" button is pressed and held for a longer time. The display shows the currently set brightness on all its segments. When the setting limit values are reached, the segments start to flash.

The modes specified below are accessible once the relevant code have been entered.

Calibration mode (CAL.) code L-1 – activated when the "ON/OFF" button has been pressed and held for a longer time. The display shows the measured temperature including the calibration. Readings specified in °C.

Preliminary heating time setting mode (P.t.) code L-2 – activated when "ON/OFF" button is pressed and held for a longer time. The display shows the working time, counting it from the activation, for which the controller performs preliminary heating maintaining the preliminary heating temperature programmed by the manufacturer. Reading "OFF" means deactivation of the preliminary heating function. Readings specified in minutes. When preliminary heating activated, the controller displays marking "HC2" during start-up.

Preliminary heating temperature setting mode (P.t.E.) code L-3 – activated when the "ON/OFF" button is pressed and held for a longer time. The display shows the value of preset temperature for preliminary heating. Readings P ... specified in °C.

Preset temperature limit setting mode (L.t.h.) code L-4 – activated when "ON/OFF" button is pressed and held for a longer time. The display shows maximum value of preset temperature that can be set. Readings L ... are specified in

4 – button „-“, value decreasing

Working mode – pressing the button will decrease the preset temperature value. During preliminary heating, the option to change the setting for preset temperature is blocked.

Working time setting mode – pressing the button will decrease the time after which the thermostat will get switched off.

Display brightness setting mode – pressing the button will decrease the brightness of the display.

Calibration mode – pressing the button will decrease the value of the temperature to be transferred, calibrating the measurement duct in this way.

Preliminary heating time setting mode – pressing the button will decrease the time after which the thermostat will switch from preliminary heating phase to proper heating phase.

Preliminary heating temperature setting mode – pressing the button will decrease the value of preset temperature that will be maintained during preliminary heating.

Preset temperature limit setting mode – pressing the button will decrease the value of maximum preset temperature that will be to set.

5 – button „+” value increasing

Working mode – pressing the button will increase the value of preset temperature. During preliminary heating, the preset temperature setting changes is blocked.

Working time setting mode – pressing the button will increase the time after which the thermostat gets switched off.

Display brightness setting mode – pressing the button will increase the brightness of the display

Calibration mode – pressing the button will increase the value of the transferred temperature, calibrating the measuring duct in this way.

Preliminary heating time setting mode – pressing the button will increase the time after which thermostat switches from preliminary heating phase to proper heating phase.

Preliminary heating temperature setting mode pressing the button will increase the value of preset temperature which will be maintained during preliminary heating.

Preset temperature limit setting mode – pressing the button will increase the value of maximum preset temperature that can be set

6 – „ON/OFF” button

Short-time pressing of the button will activate (ON) and deactivate (OFF) the regulator interchangeably. At deactivated state (OFF) the regulator act as a thermometer. At activated state (ON) , the regulator shall activate and deactivate the outlet to control the heater in order to maintain the temperature set by the user.

Longer pressing and holding of the button and subsequent button releasing will activate the working time setting mode, signalled with (Pro.) notice. In this mode, by means of “+” and “-“ buttons , the user has a possibility to define the time after which the controller gets deactivated, i.e. switches to the OFF state. Exit from the mode and setting approval occurs once the “ON/OFF” button is shortly pressed.

Longer pressing and holding of the button and its subsequent releasing will activate the display brightness setting mode – signalled with (d.br) notice.

In this mode, by means of “+” and “-“ buttons the user has the possibility to set the brightness of the display segments. Exit from the mode and confirming the setting occurs when the “ON/OFF” button is pressed shortly. Longer pressing and holding of the button and subsequent releasing of the button will activate the calibration mode, signalled by the (CAL) notice. In this mode by means of “+” and “-“ buttons, the user has a possibility to adjust the temperature readings to the real temperature. Exist from the mode and confirming the calibration settings occurs when the “ON/OFF” button is pressed shortly.

NOTE – the controllers supplied have been calibrated already.

Longer pressing and holding of the button and subsequent its releasing shall activate the preliminary heating time setting mode, signalled by (P.tl) notice. In this mode by means of “+” and “-“ buttons the user has a possibility to define the time after which the controller gets switched from preliminary heating phase to proper heating phase. Deactivation of preliminary heating is signalled by the “OFF” notice. Exist from the mode and setting confirmation occurs when the “ON/OFF” button is pressed shortly.

Longer pressing and holding of the button and its subsequent releasing will activate the preliminary heating temperature setting mode, signalled by (P.tE.) notice.

In this mode by means of “+” and “-“ buttons the user has a possibility to define the preset temperature that shall be maintained during preliminary heating. Exit from the mode and setting conformation occurs when the “ON/OFF” button is pressed shortly. Longer pressing and holding of the button and its subsequent releasing will activate the preset temperature limit setting mode, signalled by (L.t.h.) notice. In this mode by means of “+” and “-“ buttons the user has the possibility to set the upper limit of the preset temperature settings. Exist from the mode and setting confirmation occurs after the “ON/OFF” button is pressed shortly.

NOTE – all controller settings and working state (activated or deactivated) are stored in the non-volatile memory.

Entering the access codes

During controller start-up (displayed controller’s name, software version, settings), press and hold the “+” and “-“ buttons. Once “---“ has been displayed on the screen, buttons may be released and the relevant code can be set. The code shall be confirmed by the “ON/OFF” button.

CODE	ACCESS LEVEL
any	L-0
157	L-1
314	L-2
628	L-3
942	L-4

Working time setting mode (code L-0)

Display brightness setting mode (code L-0)

Calibration mode (code L-1)

Preliminary heating time setting mode (code L-2)

Preliminary heating temperature setting mode (code L-3)

Preset temperature limit setting mode (code L-4)

4.3. Controller error report

MHC1 controller has been equipped with advanced mechanisms for error detection. Detection of any error activates emergency work stoppage and triggers error report screen. Error report screen is displayed in a continuous manner. It is therefore necessary to disconnect power supply, remove the error source and controller reactivation

ERROR	ERROR DESCRIPTION
(E-0) CPU STATUS	Damaging the main processing unit.
(E-3) $T < T_{min}$	Too low temperature measured by T1 sensor.
(E-4) $T > T_{max}$	Too high temperature measured by T1 sensor.
(E-5) button -	“-“ button damage/pressing
(E-6) button +	“+“ button damage /pressing
(E-7)button ON/OFF	“ON/OFF” button damage/pressing

4.4. Controller's technical parameters

CONTROLLER'S TECHNOLOGICAL PARAMETRES (STATE FOR FW: 0.1)	
Temperature measurement range*:	-50°C ... +250°C
Temperature readout resolution:	0,1°C
Temperature measurement accuracy:	± 1,5 °C
Setting range for preliminary heating time:	0 ... 60 minutes
Regulation type:	bistate
Controller's electrical parameters	
Power supply for the controller board:	12VDC ±10%, Min. 200mA
Power supply of dedicated feeder:	100...240VAC 50/60Hz
Measurement input for temperature measurement	PT1000
Outlet type:	Relay, contact NO
Output load:	AC1 - 9A 230V
Maximum power of the heater attached:	2000W 230VAC
Outlet switching durability	> 3 x 10 ⁴ for 10A 230VAC
Maximum switching frequency AC1	600 cycles/h
Environmental conditions	
Temperature of the regulator in operation:	0°C...55°C

Before the first use, the creamer must be thoroughly washed and dried. The creamer must be washed with hot water by means of a soft flannel cloth with the addition of agents approved for the contact with equipment used in the food industry, and then carefully flushed with clean water, remembering about securing electronic elements and bearings against wetting!!!

The machine must be stored in a dry room. No elements of the machine can be maintained with chemical agents.

7. Utilisation

The Worn out product shall be subject to disposal as waste only in the selective collection of waste organized by

Minimal value of preset temperature:	30°C
Maximum value of preset temperature:	Set up in the range: 45°C ... 95°C
Setting range for automatic deactivation:	1 ... 96 h
Setting range for preliminary heating temperature:	30°C ... 40°C

Ambient temperature for stored regulator:	0°C...60°C
Air humidity for the regulator in operation:	Max 65% at 25 °C

Storage of honey creaming machine

After completion of the honey harvest, the device must be thoroughly cleaned and dried.

Before starting the honey creaming machine, in the case when it has been moved from the room with the lower temperature to spaces of higher temperature, you should wait until it reaches the ambient temperature. Store in dry rooms at a temperature above 0° C.

Before each new season, one should make an additional technical review, and in the event of fault detection, please contact the service center.

6. Maintenance of the creamer



IMPORTANT!

Before commencing the maintenance, pull out the mains plug!!!

Network of Municipal Collection Points for Waste Electrical and Electronic Equipment. The consumer shall have the right to return used equipment in the electrical equipment distributor network, at least, free of charge and directly if a device that is returned is the proper kind and provides the same functionality as the newly purchased equipment.

IMPORTANT!!!

Wash the covers using warm 25 [°C] soapy water.

NOTE!!!

Do not use alcohol for cleaning (it may cause surface cracks of the cover).

8. Warranty

Products purchased in the "Łysoń" company are covered by manufacturer's warranty. The warranty period is 24 months.

On purchased products shall be issued a receipt or VAT invoice.