

MANUAL

RADIAL HONEY EXTRACTORS MINIMA SERIES

800 – 900 MM CONTROLLING



LYSON

Przedsiębiorstwo Pszczelarskie Tomasz Łyson

Spółka z o.o. Spółka Komandytowa

34-125 Sułkowice, ul. Raclawicka 162, Polska

www.lyson.com.pl, email; lyson@lyson.com.pl

tel. 33/875-99-40, 33/870-64-02

Siedziba Firmy Klecza Dolna 148, 34-124 Klecza Górna

2016

The manual encompasses the honey extractor bearing the following codes:

RADIAL HONEY EXTRACTORS WITH SDD POWER SUPPLY

W20050M, W20060M,

CONTENTS

1. General safety operational principles for the honey extractor
 - 1.1. Operational principles
 - 1.2. Electrical safety
 - 1.3. Operational safety
2. Manual for honey extractor
 - 2.1. General principles for preparing the honey extractor for operations
 - 2.2. Operational principles
3. Honey extractor diagram
4. Characteristics for honey extractors
 - 4.1. Radial honey extractor – MINIMA series
 - 4.1.1. Technical parameters
 - 4.2. Controlling in radial honey extractor
 - 4.2.1. Characteristics for controlling
5. Honey extractor storage
6. Maintenance and clearing the honey extractors
 - 6.1. Dismantling the basket in honey extractor
7. Recycling
8. Guarantee



1. General safety operational principles for the honey extractor

Prior to device usage initiation, refer to the following manual and act according the guidelines contained therein. The manufacturer shall not be held accountable for any damages caused by improper usage of the device or its improper handling

1.1. Operational principles

1. The honey extractor is intended to centrifuge the honey from the frames .
2. The honey extractor must be washed thoroughly prior to usage with water containing slight amount of agents admissible to be used in cleaning the devices coming into contact with food or by means of a pressure washer, remember to protect the electronic components and bearings against damping !!!

Honey extractors with 12V controller must not be connected to a power supply from a rectifier as it may damage the controller.

The aforementioned damage is not included in the guarantee.

Battery of a feeder from “Łysoń” company remains a proper source of power.



1.2. Electrical safety

1. If non-detachable power supply cable gets damaged and must be replaced, it must be performed at a guarantor's or by a specialised repair centre or by a qualified person in order to avoid any threat.
2. Do not operate the honey extractor when the power supply cable is damaged.
3. Prior to plugging in the device to the mains, check whether controller is switched off. 0/1 switch on the controlling panel should be in “0” position .
4. Check the honey extractor and the power source for nominal voltage compliance (battery of feeder from Łysoń company).
 1. Be careful while connecting the device to the mains. Hands must be dry!
 5. The floor on which the extractor has been placed must be dry!
 6. The honey extractor lid must be closed during spinning!. It is forbidden to open the lid during spinning.
 7. While spinning, the honey extractor must not be displaced.
 8. The engine and the controller must be protected against damping; (also during the storage).
 9. It is forbidden to pull the supply cable. The supply cable must be kept away from heat sources, sharp edges and its good technical state must be taken care of.

1.3. Operational safety

1. The following equipment is not intended to be used by persons with limited physical, sensory or mental capabilities (including children) or persons inexperienced or unfamiliar with that type of equipment unless the usage occurs under supervision or in line with the equipment operating manual provided by safety supervising persons. One must make sure that children do not play with the honey extractor.
2. In case of any damage to the honey extractor, in order to avoid the danger, the repairs may be performed solely by a specialist servicing centre or a qualified person.
3. It is forbidden to perform any maintenance works or repairs when the device is in operation.
4. Honey extractor may be restarted once the danger has been eliminated.
5. The device cannot be activated and stored with the ambient temperature below 0° C. Honey extractor cannot be activated when the ambient temperature drops below 5° C. When the honey extractor has been moved from a room with a lower temperature to a room with a higher temperature, prior to its activation one must wait until the device has achieved the ambient temperature.

It is forbidden to make any repairs while the device is under operation



It is forbidden to remove any shields while the device is under operation

2. Honey extractor manual

2.1 General principles for preparing the honey extractor for operation

1. Place the honey extractor in the place specified for the purpose and kept in order and cleanliness
2. Fix the honey extractor to the ground in order to avoid its displacement during spinning.

2.2 Operating principles

1. Honey extractor is intended to centrifuge the honey from the frames.
2. Prior to extraction, the honey extractor must be washed thoroughly in line with the guidelines contained in the chapter **Honey extractor maintenance**.
3. While washing, take special precautions to prevent the engine and the controller against damping (it can be covered with a water-proof material)

4. After washing, rinse and dry the honey extractor thoroughly.
5. Frame arrangement:
 - Honey extractor must be properly selected for a given frame type.
 - Frames must be placed inside the basket in line with the pattern (photo 1)



Phot.1 Proper frame arrangement inside the radial honey extractor



NOTE!

Erroneous frame arrangement may bring about the damages which are not subject to guarantee terms!

6. Prior to the honey extractor activation, one must:
 - make sure that the frames have been properly arranged inside the basket in order to eliminate the risk of damage.
 - next, connect the honey extractor to the feeder/battery (12V) and activate the device in line with the manual
7. The first phase of extraction shall be performed slowly in order to prevent the honeycombs from breaking out. Special attention must be paid to the so called "young frames".
8. The spinning basket should not be blocked by the honey accumulating inside the drum. If that is the case, the honey extractor must be stopped in order to avoid any damage. Once the honey has drained to the containers, spinning may be restarted.
9. A container intended for the honey shall be placed under the drain valve..
10. While spinning the drain valve should be opened in order for the honey to flow freely.

3. Honey extractor diagram

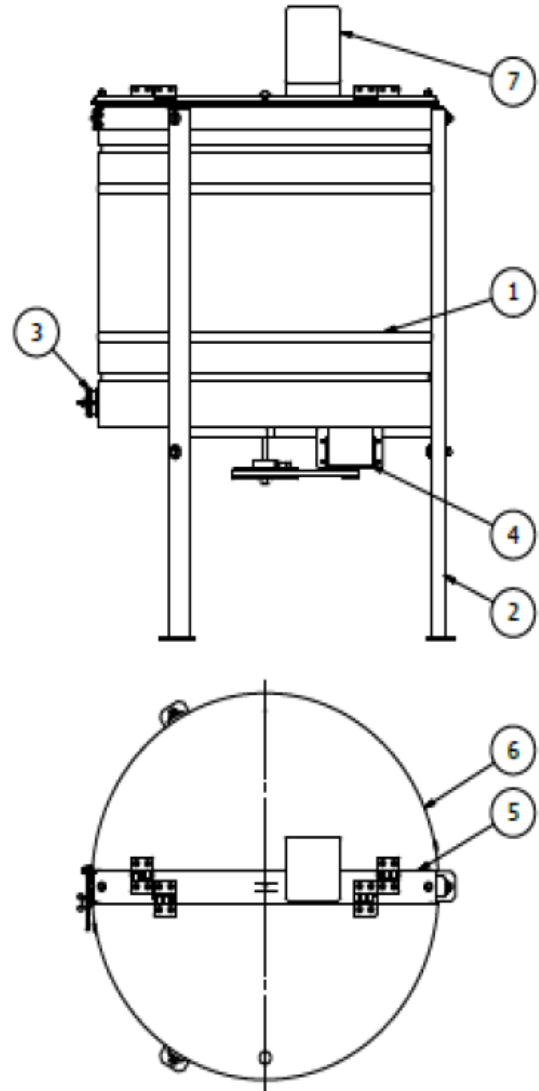

Legend:

1. Honey extractor drum
2. Honey extractor leg
3. Drain valve
4. Honey extractor engine
5. Honey extractor beam
6. Honey extractor lid
7. Fixing controlling

4. Characteristics for honey extractor

The controller in a plastic casing is fixed to the honey extractor beam. The honey extractors are sent with dismantled controller, placed inside the basket, in order to prevent against damages during transit.

4.1. Radial honey extractor with 12 V power supply

Honey extractors are intended for stationed and movable apiaries. Power supply from a battery (12V) allows to extract the honey without the access to the mains (230V). Honey extractor may be operated in manual and automatic mode.

4.1.1 Technical parameters

- The drum made of stainless and acid-resistant steel plate 0H18N9, property reinforced and stiffened
- Honey extractors have the drum and bottom made of 0.6 mm steel plate. One plastic drain valve 6/4"
 - Basket made of stainless and acid-resistant rods $\varnothing 3$ and $\varnothing 5$
- Lid made of metaplex
 - engine 350W/24V in the honey extractor with the diameter 800mm
- honey extractors have bottom drive with belt transmission

4.2. Controller in radial honey extractor of MINIMA series



Controller has a „0/1” switch serving for activating and deactivating the honey extractor as well as a safety switch (big, round, red button – EMERGENCY STOP) serving for immediate stop for the honey extractor as well as a fuse (5A) located under “0/1” switch.

Controlling panel is equipped with navigating buttons „PLUS”, and „MINUS” and the „STOP” button

Controller’s characteristics:

SDD regulator has an option to select the rotation characteristics individually to get adjusted to the supply conditions and to the parameters of the engine connected. The choice of characteristics is based on setting up three parameters: one responsible for lower limitation of engine rotational speed (L parameter), upper limitation of engine rotational speed (parameter H) and the ramp-up time (parameter A). Operational characteristics are to be selected in the following manner:

Configuration „L0” - low rotational speed for the speed index 1

.....
Configuration „L9” - medium rotational speed for the speed index 1

.....
Configuration „LF or J” - high rotational speed for the speed index 1

Configuration „H0” - low rotational speed for the speed index 10

Configuration „H9” - medium rotational speed for the speed index 10

.....
Configuration „HJ” - high rotational speed for the speed index 10

Configuration „A0” - low engine dynamics (long ramp-up time)

.....
Configuration „A9” - medium engine dynamics (medium ramp-up time)

.....
Configuration „AF or J” - high engine dynamics (short ramp-up time)

Additionally, the following parameters are defined during subsequent controller configuration steps: t – establishing the type of regulation, i.e. defining the basket ramp-up time; and

Configuration „t0” - regulator with slow ramp-up time (range 90s – 900s)

Configuration „t1” - regulator with fast ramp-up time (range 10s – 100s)

Controller start-up:

When power supply gets connected to the device, switch the '0/1' switch to position "1", the controller performs auto-diagnostic sequence, which is signalled by flashing "0" digit. Once the auto-diagnostic sequence has terminated, the regulator switches into normal operation mode – waiting to be activated. "0" shall appear at the screen,

Honey extractor start-up:

In order to activate the honey extractor, press PLUS button .

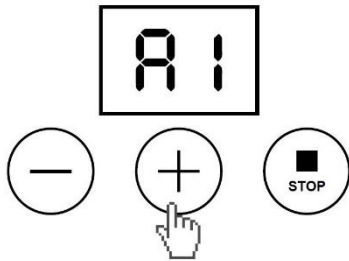

Pressing PLUS button for the first time, in order to decrease the rotations press MINUS button

By pressing „PLUS” (increase) or „MINUS” (decrease) buttons we change the basket rotating Speer within the range 1 to 10. See the figure below.

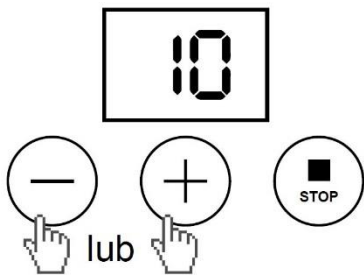

In order to stop the honey extractor, press STOP button or press MINUS button several times.

The rotation deactivation is signalled by 0. See the figure below.

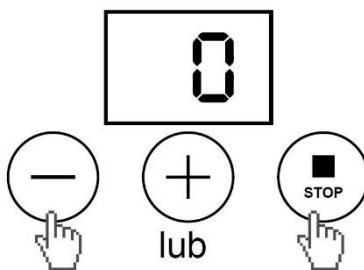

Controller's configuration:

If during the honey extractor start-up the basket does not start rotating or rotates too quickly, this means that controller's configuration must be changed. In order to do that, Press STOP button. Switch off the honey extractor by 0/1 switch, change position to 0, wait a moment and change to 1 position again. Flashing 0 shall appear on the screen. When 0 is flashing, press and hold STOP button until „Pr-Programming” message has appeared .

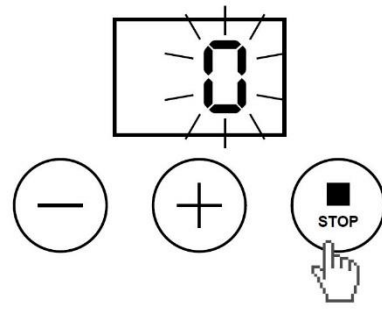

Changing the current controller's configuration occurs through changing the parameter setups.

1. Press the **STOP** button at the device start ("0" flashes in the screen), subsequently release the button when "Pr" message appears".
 2. By means of the **plus** and **minus** buttons set up the lower limits of rotational speed („L0" ... „LJ" – depending on the type of extractor Parameter L from 0 to J*).
 3. Confirm the set-up by pressing the STOP button shortly.
 4. By means of the **plus** and **minus** buttons set up the upper limits of rotational speed („H0" ... „HJ" – depending on the type of extractor parameter H from 0 to J*).
 5. Confirm the set-up by pressing the STOP button shortly.
 6. By means of the **plus** and **minus** buttons set up the engine start-up dynamics („A0" ... „AJ" – depending on the type of extractor parameter A from 0 to J*).
 7. Confirm the set-up by pressing the STOP button shortly.
 8. By means of the **plus** and **minus** buttons set up the regulation type („t0" or „t1")
 9. Confirm the set-up by pressing the STOP button shortly.
- Established configuration will be stored in the controller's non-volatile memory.
10. Test the set-ups and perform the configuration sequence again, if needed
- * (parameters A,B,C,D,E,F,G,H,I,J mean the numbering: 10, 11, 12, 13, 14, 15, 16, 17, 18, 19, 20)

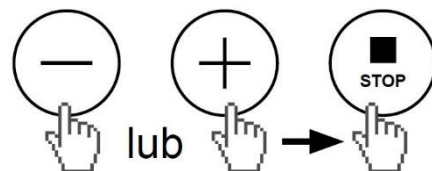

MICROPROCESSOR CONTROLLER	
The number of speed regulation steps:	10
Regulation type:	PWM
Display:	LED, 7-segment, 2-item

The number of configuration steps for the Lower range of rotational speed (L):	0-20 (1,2,3,4,5,6,7,8,9,a=10,b=11,c=12..etc)
The number of configuration steps of the Upper range of rotational Speer (H):	0-20 (1,2,3,4,5,6,7,8,9,a=10,b=11,c=12..etc)
The number of configuration steps for engine acceleration (A):	0-20 (1,2,3,4,5,6,7,8,9,a=10,b=11,c=12..etc)
The number of possible regulation type (t):	2
Minimum ramp-up time for the setups: L0 / HJ / AJ / t0	90 seconds
Minimum ramp-up time for the setups: L0 / HJ / A0 / t0 Parameter t –honey extractor Ø 800 and above	900 seconds
Minimum ramp-up time for the setups: L0 / HJ / AJ / t1	10 seconds
Maximum ramp-up time for the setups: L0 / HJ / A0 / t1 Parameter t – honey extractors Ø 600	100 seconds
Supply-executive module SDD-1	
Module power supply:	18V – 21V AC
Recommended transformer power:	80VA
Max. loading for regulator outlet:	3,5A – electronically limited

Supply-executive module SDD-2	
Module power supply:	18V – 21V AC
Recommended transformer power:	120VA
Max. loading for regulator outlet:	5,5A – electronically limited
Environmental conditions	
Ambient temperature for	0°C...40°C

regulator under operation:	
Ambient temperature for regulator under storage:	0°C...50°C
Ait humidity for operating regulator:	Max 65% dla 25°C
Air humidity for regulator under storage:	impermissible

Once the auto-diagnostic sequence has terminated, the regulator switches into normal operation mode – waiting to be activated. "0" shall appear at the screen, which signals rotation deactivation. Rotations get activated by pressing the **plus** button. Pressing the plus button for the first time (switching from 0 index to index 1) shall commence the start-up sequence. The regulator shall start with a higher power in order for the power to decrease gradually to the level identified for the first step of the setup. The regulator switches into the normal operation mode and signals the currently selected speed index, as below

2.E. ERROR CODES

- E1 - (Error) – internal fault of a microprocessor controller
- E2 - (Error) – damaging the regulator's overcurrent protection
- E3 - (Error) – short circuit at the line/ pressing the (-) button
- E4 - (Error) – short circuit at the line / pressing the (+) button
- E5 - (Error) – short circuit at the line / pressing the STOP button
- E6 - (Warning) – deleting the controller configuration setups

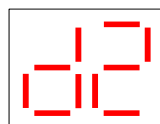

WYKRYTO 2 BŁĘDY

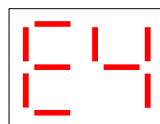

OSTATNI BŁĄD O KODZIE E4

5. Storing the honey extractors

Once the honey harvesting has terminated the device is to be washed thoroughly.

Prior to the honey extractor start-up, in case when it has been transferred from a room with a lower ambient temperature to a room with a higher one, one must wait until the device has reached the ambient temperature.

The device is to be stored in dry rooms with the temperature above 0° C.

Before every season, an additional technical inspection must be performed and in case when any defects have been detected, a service centre must be contacted

6. Maintenance and cleaning



IMPORTANT!

Before maintenance, the honey extractor must be disconnected from the supply source (battery or feeder made by Łysoń company).

After honey harvesting time honey extractor shall be washed thoroughly with hot water containing slight quantities of agents accepted to be used in food processing industry or by means of a pressure washer. Be careful during the washing and prevent dumping the honey extractor engine or controller (they may be covered with water-resistant materials).

While washing, prevent the bearing located under the drum from being flooded . For this purpose, the orifice through which the basket axis goes must be covered inside the basket.

After washing, the honey extractor must be rinsed with pure water and dried. Before every season additional technical inspection must be performed and in case any faults are detected a service point must be contacted.

After the washing, the honey extractor must be rinsed and dried thoroughly.

6.2. Dismantling the basket in radial honey extractors

- Loosen and remove the V-belt
- Loosen the screw on the pulley
- Unscrew and remove the upper beam with the lids
- Take the basket out

7. Recycling

Worn-out product must be removed as waste only within selective waste collection organised by the Network of Communal Electric and Electronic Waste Collecting Points. A customer is entitled to return the used equipment to the electrical equipment distributor network, at least free of charge and directly, if the device to be returned is of proper type and serves the same purpose as the newly purchased device.

8. Guarantee

The products purchased in “Łysoń” company are encompassed by the manufacturer’s guarantee.

The guarantee period equals 5 year.

The guarantee period excludes the components of a controlling unit, a drive and electric elements. A two-year guarantee applies to them.

A receipt or a VAT invoice is issued for each product purchased.