

Manual

Honey extractors – MINIMA series with manual or electric drive



LYSON 

Przedsiębiorstwo Pszczelarskie Tomasz Łyson

Spółka z o.o. Spółka Komandytowa
34-125 Sulkowice, ul. Raclawicka 162, Polska
www.lyson.com.pl, email: lyson@lyson.com.pl
tel.33/875-99-40 , 33/870-64-02
Siedziba Firmy Klecza Dolna 148 , 34-124 Klecza Górna

This manual encompasses the devices with the following codes:

W224B , W2026B , W2027B , W2029B ,
W2030B , W 2033B

Manual

1. General safety operational principles
 - 1.1. Operational principles
 - 1.2. Electrical safety
 - 1.3. Operational safety
2. Honey extractor manual
 - 2.1. General principles for preparing the device for operation
 - 2.2. Operational principles
3. Characteristics of the honey extractors - MINIMA series
 - 3.1. Technical parameters for electric honey extractors
 - 3.2. technical parameters for manual honey extractors
 - 3.3. Dismantling the basket in case of manual and electric honey extractors
4. Device storage
5. Maintenance and cleaning
6. Recycling
7. Guarantee

1. GENERAL SAFETY OPERATIONAL PRINCIPLES

Prior to device usage initiation, refer to the following manual and act according to the guidelines contained therein. The manufacturer shall not be held accountable for any damages caused by improper usage of the device or its improper handling

1.1. Operational principles

1. The honey extractor is intended to centrifuge the honey from the frames.
2. The honey extractor must be washed thoroughly prior to usage with water containing slight amount of agents admissible to be used in cleaning the devices coming into contact with food or by means of a pressure washer.

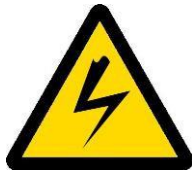

1.2. Electrical safety

1. Power supply electric installation must be equipped with RCD with nominal tripping current In below 30 mA. Functioning of overcurrent circuit breaker must be checked periodically .
2. If non-detachable power supply cable gets damaged and must be replaced, it must be performed at a guarantor's or by a specialised repair centre or by a qualified person in order to avoid any threat. Do not operate the honey extractor when the power supply cable is damaged.
3. Prior to plugging in the device to the mains, check whether controller is switched off. 0/1 switch on the controlling panel should be in "0" position.
4. Check the honey extractor and the power source for nominal voltage compliance.
5. Be careful while connecting the device to the mains.
Hands must be dry!
The floor on which the extractor has been placed must be dry!
6. The honey extractor lid must be closed during spinning!. It is forbidden to open the lid during spinning.
7. While spinning, the honey extractor must not be displaced.
8. In case of the honey extractor with electric controlling, the engine and the controller must be protected against damping; (also during the storage).

9. It is forbidden to pull the supply cable. The supply cable must be kept away from heat sources, sharp edges and its good technical state must be taken care of.



1.3. Operational safety

1. The following equipment is not intended to be used by persons with limited physical, sensory or mental capabilities (including children) or persons inexperienced or unfamiliar with that type of equipment unless the usage occurs under supervision or in line with the equipment operating manual provided by safety supervising persons. One must make sure that children do not play with the honey extractor.
2. In case of any damage to the honey extractor, in order to avoid the danger, the repairs may be performed solely by a specialist servicing centre or a qualified person.
3. It is forbidden to perform any maintenance works or repairs when the device is in operation.
4. All shields must be permanently attached to the honey extractor while operating it.
5. The device cannot be activated and stored with the ambient temperature below 0° C. Honey extractor cannot be activated when the ambient temperature drops below 5° C. When the honey extractor has been moved from a room with a lower temperature to a room with a higher temperature, prior to its activation one must wait until the device has achieved the ambient temperature.



It is forbidden to make any repairs while the device is under operation



It is forbidden to remove any shields while the device is under operation

2. HONEY EXTRACTOR MANUAL

2.1 General principles for preparing the honey extractor for operation

1. Place the honey extractor in the place specified for the purpose and kept in order and cleanliness.
2. Fix the honey extractor to the ground in order to avoid its displacement during spinning.

2.2. Operating principles

1. Honey extractor is intended to centrifuge the honey from the frames.
2. Prior to first extraction and after the honey harvesting, the honey extractor must be washed thoroughly in line with the guidelines contained in the chapter **Honey extractor maintenance**.
3. Previously prepared frames must be placed inside the basket, with special attention paid to their arrangement. Erroneous frame arrangement may bring about the damages which are not subject to guarantee terms!
4. Prior to the honey extractor activation, one must:
 - Put the plug into the socket, switch the controlling activation button on the controlling cabinet from "0" to "1" position.



5. The first phase of extraction shall be performed slowly in order to prevent the honeycombs from breaking out. Special attention must be paid to the so called "young frames".
6. Rotations are regulated by a potentiometer.



NOTE!!! Frames may be rearranged only when the honey extractor basket has come to a complete hold!

9. Once the basket has stopped, reverse the frames by 180 degrees and centrifuge the other

side of the honeycomb. The frames are to be centrifuged in two stages, first with lower rotations on both sides of the honeycomb. Subsequently, with higher rotations of the basket on both sides of the honeycomb again.

10. The spinning basket should not be blocked by the honey accumulating inside the drum. If that is the case, the honey extractor must be stopped in order to avoid any damage. Once the honey has drained to the containers, spinning may be restarted.

11. A container intended for the honey shall be placed under the drain valve. While spinning the drain valve should be opened in order for the honey to flow freely.

3. Characteristics for the honey extractors – Minima series.

Diagonal, 3-4-honeycomb honey extractor can be used in small apiaries as well as by the apiarists treating beekeeping as a hobby. Its distinguishing features include compact dimensions and easy handling. Designing solutions applied make it possible to centrifuge even the densest honey. The conical shape of the extractor's bottom allows for the honey to drain freely. Honey extractors are packed in carton boxes, for self-assembling.

3.1. Technical parameters of electric honey extractor

Drum of the honey extractor is made of stainless and acid-resistant steel plate, thickness 0.6 mm. The proper arrangement of the rabbets reinforces the drum construction even more.

Basket design

Diagonal basket made of stainless and acid-resistant rods, thickness 2 and 5 mm, arranged in the way protecting the frames from honeycombs breaking out during spinning. Meshing size 20x20 mm. The basket placed on the sliding-retaining sleeve.

Electric drive

The honey extractors are supplied by the mains voltage 230V. The rotation potentiometer has been applied as well. The engine with transmission is mounted on the upper beam.

Lid

Transparent lid made of metaplex, thickness 3 mm, protects a user against the hazard of coming into contact with a spinning basket and getting dirty.

Drain valve

Made of plastic, 6/4"

- Drum height (without the drive)-610

- Drum height with the drive, with legs- 950mm.
- Honey extractor's weight – 24.5 kg diameter 600mm
- Honey extractor's weight – 21 kg diameter 500 mm
- Legs and beam ate powder-coated

Plexiglas with four orifices - 1 piece





Components of the honey extractor with electric drive:

- Drum with the engine installed
- Assembling elements (list below)
- Lid (2 pcs).
- Plastic valve (c)
- MDD controlling
- Honey extractor's legs (b)
- Manual
- Guarantee

 e. bolt to screw the handle – 1 piece

 f. handle to lift the lid – 1 piece

 g. lid hinge – 4 pcs

 h. plastic washers – 8 pcs

 conical Allen screw 5x25 – 8 pcs.
i1. Conical Allen screw M5x30 – 8 pcs.

 j. washer extended to hold the nuts for Plexiglas – 8 pcs

 j1. washer 5 for beam nuts 8 pcs.

 k. nut for conical Allen bolts for Plexiglas and beam M5 – 16 pcs
wrench 8/10 – 1 pc
Allen wrench 3 – 1 pc.

The list of assembling elements:

Leg fixing:

 a. leg fixing knob - 6 spcs

 b. legs – 3 pcs

Lid fixing:

d. Upper lid made of Plexiglas with five orifices - 1 pc

d1. Rear lid made of



Controller fixing:

 l. honey extractor's control unit

 l1. Cap nut M8 – 2 pcs



l2. washer 8 – 2 pcs.



l3. bolt M8x25 – 2 pcs

Wrench 10/13 – 2 pcs

Assembling the MINIMA-series honey extractor with electric drive

1. Take the drum with installed engine out of the carton box
2. Take out the elements for self-assembling
3. Assemble the legs and the valve
4. assemble the Plexiglas
5. assemble the controlling unit

Fixing the controlling unit



a. Fixing the valve

b. Fixing the legs

Screwing the hinges to the beam

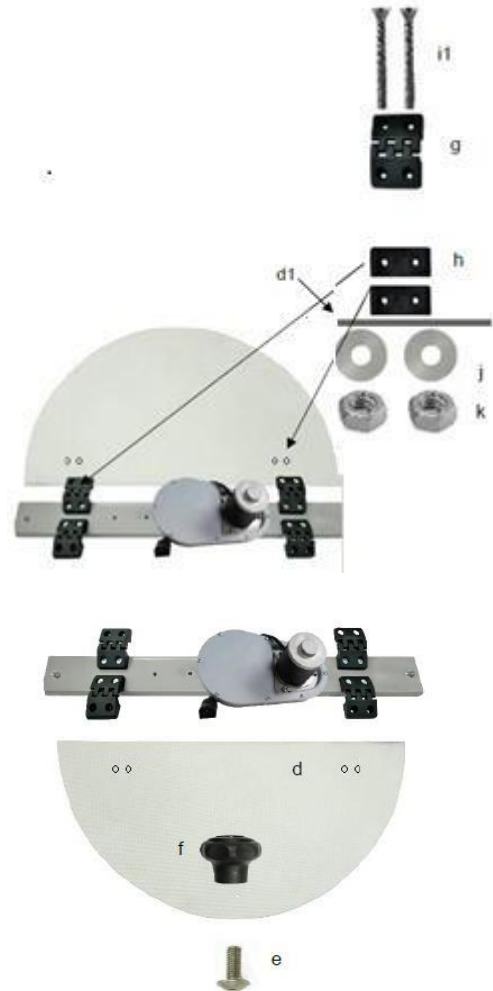

Knob folding to the plexiglass



3.2. Technical parameters of the manual honey extractor

Drum of the extractor is made of stainless and acid-resistant steel plate, thickness 0.6 mm. The proper arrangement of the rabbets reinforces the drum construction even more.

Basket design

Diagonal basket made of stainless and acid-resistant rods, thickness 2 and 5 mm, arranged in the way protecting the frames from honeycombs breaking out during spinning. Meshing size 20x20 mm. The basket placed on the sliding-retaining sleeve.

Manual drive with a brake mounted on the upper beam of the extractor. Makes it possible to operate the device when the access to electricity is impossible. Manual drive casing is made of powder-coated metal. Steel rolled gears transfer the torque to the basket axis.

Lid

Transparent lid made of metaplex, thickness 3 mm, protects a user against the hazard of coming into contact with a spinning basket and getting dirty .

Drain valve-plastic, 6/4"

- Drum height (without drive)-610mm.
- Drum height, without drive, with legs-950mm.
- Extractor weight – 24.5 kg d= 600mm
- Extractor weight –21 kg d= 500 mm
 - Legs and beam powder-coated

Components of the Minima-series extractor with manual drive

- Drum with engine mounted
- Assembling elements (list below)
- lid 2 pcs
- plastic valve
- extractor's legs
- manual
- guarantee

List of assembling elements:

Fixing the legs



a. knob to fix the legs - 6 pcs.



b. extractor's legs – 3 pcs

Fixing the handle



d. Allen bolt M8x110 - 1 piece



e. handle - 1 piece



f. cap nut M8 - 1 piece

Wrench 10/13 – 1 piece

Allen wrench 6 – 1 piece

Fixing the lid:

g. front lid made of Plexiglas with five orifices - 1 piece



g1. Rear lid made of Plexiglas with four orifices – 1 piece.



h. bolt to screw up the handle to plexiglas – 1 piece



i. grip to lift the extractor lid – 1 piece





j. lid hinge – 4 pcs





k. plastic washers – 8 pcs

 m. conical Allen bolt M5x25 – 8 pcs.

 m1. Conical Allens bolt
M5x30 – 8 pcs

 n. washer 5 widened for the nuts for the plexiglas – 8 pcs.

 n1. washer 5 for the nuts for the beam – 8 pcs

 o. nut for a conical Allen bolt for plexiglas and beam M5 – 16 pcs

Wrench 8/10 – 1 piece
Allen wrench 3 – 1 piece

ASSEMBLING THE HONEY EXTRACTOR WITH MANUAL DRIVE

1. Extractor drum with assembled manual drive shall be taken out of the carton box
2. Take out the set of assembling elements for self-assembly
3. Assembling the legs and valve
4. Assembling the handle
5. Assembling the Plexiglas

ASSEMBLING THE HANDLE



d.

b. a.

Valve assembling Leg assembling

SCREWING UP THE LID TO THE TOP BAR

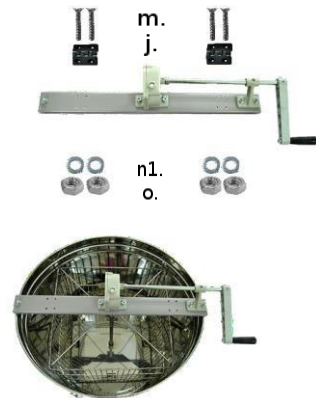

Plexiglass cover folding to the top bar

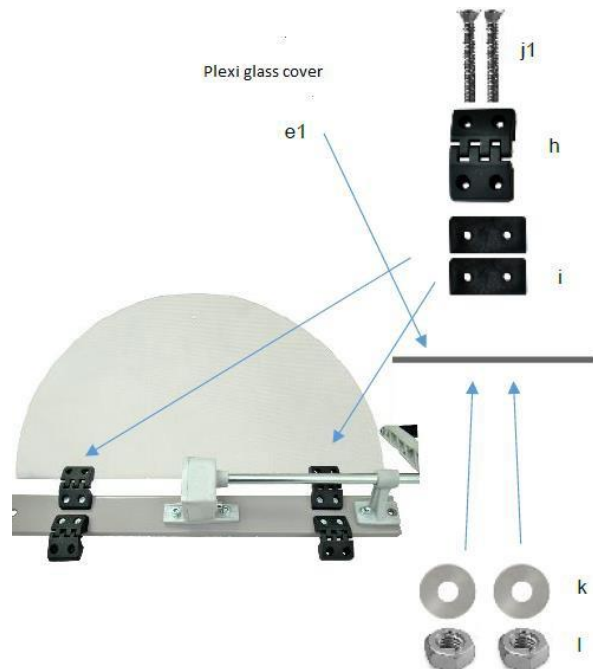



Prior to starting the maintenance, the plug must be taken out!

Knob folding to the plexiglass



After honey harvesting time honey extractor shall be washed thoroughly with hot water containing slight quantities of agents accepted to be used in devices intended to come into contact with food or by means of a pressure washer. Be careful during the washing and prevent dumping the honey extractor engine or controller (they may be covered with water-resistant materials)

After washing, the honey extractor must be rinsed with pure water and dried. Before every season additional technical inspection must be performed and in case any faults are detected a service point must be contacted.

3.3. Dismantling the basket in manual and electric honey extractors

- Unscrew the upper beam by means of black knob together with drive and lids
- Remove the basket
- Clean the extractor
- Insert the basket to the drum
- Fix the beam with the drive and lids

4. Storing the honey extractors

Once the honey harvesting has terminated the device is to be washed thoroughly. Prior to the honey extractor start-up, in case when it has been transferred from a room with a lower ambient temperature to a room with a higher one, one must wait until the device has reached the ambient temperature. The device is to be stored in dry rooms with the temperature above 0° C. The honey extractor must not be activated when the ambient temperature drops below 5 degrees C. Before every season, an additional technical inspection must be performed and in case when any defects have been detected, a service centre must be contacted

5. Extractor maintenance and cleaning

ATTENTION!!!

Device cover to be washed with soapy water at room temperature 25

IMPORTANT!!!

Do not use any detergents with alcohol (causes cracking in plexi glass)

6. Recycling

Worn-out product must be removed as waste only within selective waste collection organised by the Network of Communal Electric and Electronic Waste Collecting Points. A customer is entitled to return the used equipment to the electrical equipment distributor network, at least free of charge and directly, if the device to be returned is of proper type and serves the same purpose as the newly purchased device.

7. Guarantee

Product purchased from “Łysoń” company are encompassed by the manufacturer’s guarantee.

The guarantee duration equals 2 years Na A receipt or a VAT invoice is issued for each product purchased

Details on the guarantee terms, see the regulation on:

www.lyson.com.pl